



GRAIN AUGERS

Quality, strength and efficiency

– augers and transportation for your crops...





The incredible grain auger...

The MKX auger is supplied with a practical mechanically driven hopper to dump the grain in and a wide transport wheel kit that ensures a stable working situation.

The height of the auger is easily adjusted by one or two hydraulic cylinders.

- Canadian high quality auger with the world's largest capacities
- Well tested construction
- For tractor PTO
- Suited for filling large grain stores and outside bins
- Mobile – can be used on several farms
- Low operation expenses

Capacity

MKX 80:	up to 110 tons wheat/hour (8" = 203 mm)
MKX 100:	up to 160 tons wheat/hour (10" = 254 mm)
MKX 130:	up to 280 tons wheat/hour (13" = 330 mm)
MKX 160:	up to 550 tons wheat/hour (16" = 406 mm)

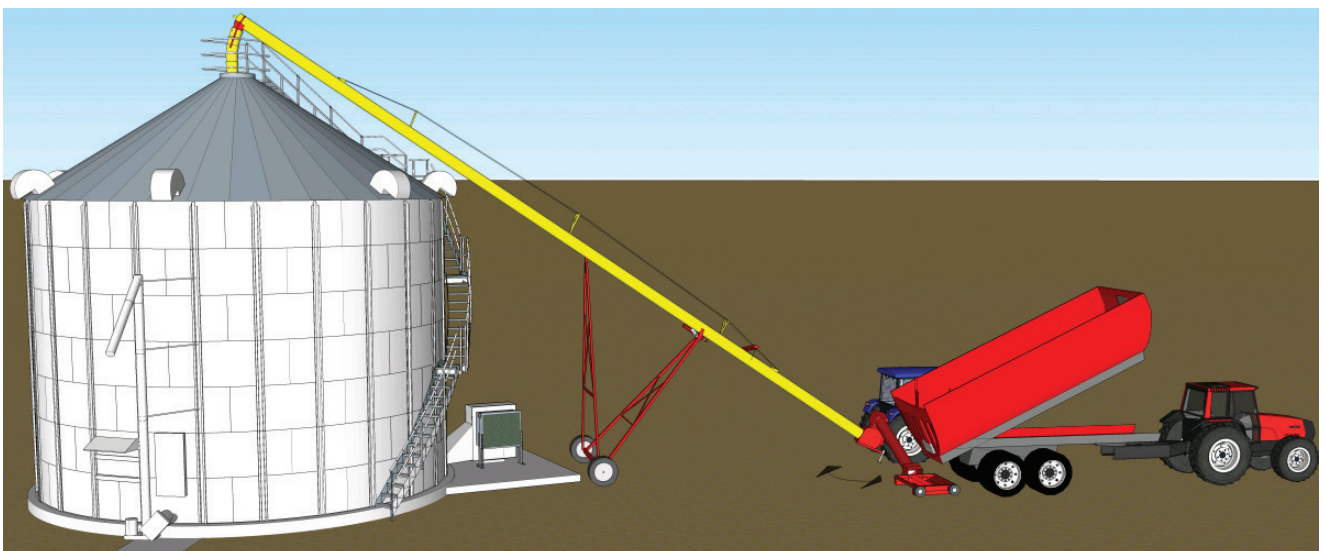



MKX auger

TYPE	LENGTH (m)	EFFECT PTO-hp	DIMENSIONS IN MM (Lowest/highest)		
			A	B	
MKX 80 X 71	21,5	50	3800 / 14140	10200 / 8250	
MKX 100 X 63	18,9	60	3500 / 12300	7800 / 9100	
MKX 100 X 73	21,9	70	3800 / 14400	8700 / 10800	
MKX 100 X 83	24,9	80	3500 / 16500	9800 / 12900	
MKX 130 X 74	22,2	130	3500 / 12300	7800 / 9100	
MKX 130 X 84	25,2	140-160	3800 / 14400	8700 / 10800	
MKX 130 X 94	28,2	150-170	3500 / 16500	9800 / 12900	*
MKX 130 X 114	34,2	170-190	3800 / 14400	8700 / 10800	*
MKX 160 X 85	25,5	180	3300 / 10800	6500 / 7800	*
MKX 160 X 105	31,5	210	3500 / 12300	7800 / 9100	*
MKX 160 X 125	37,5	230	3800 / 14400	8700 / 10800	*

Complete auger incl. wide undercarriage with wheels, swing hopper and PTO.
Excl. flexible outlet.

*) Not standard stock item - longer delivery time must be expected.

Dimensions for MKX augers ▼

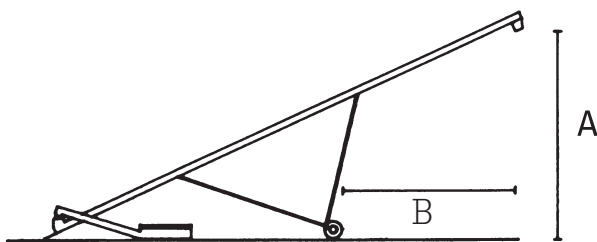

Accessories for MKX auger

Flexible outlet spout in poly material: 8-10", 5 parts, l: 900 mm

Flexible outlet spout in poly material: 13", 5 parts, l: 1250 mm

Flexible outlet spout in poly material: 16"

Cone shaped special outlet Ø160-Ø300 for 6", 8", 10" & 13" outlet





▶ Strong mobile auger

- Flexible
- Canadian high quality auger with high capacity
- For electrical motor or tractor PTO drive
- Suited for filling large grain stores and outside bins
- Value for money

▶ Capacity

AUGER DIAMETER	15° INCLINE	30° INCLINE	40° INCLINE
8" (203 mm)	70	53	45
10" (254 mm)	120	92	78
13" (330 mm)	160	120	104

Capacity may vary due to the protection net.

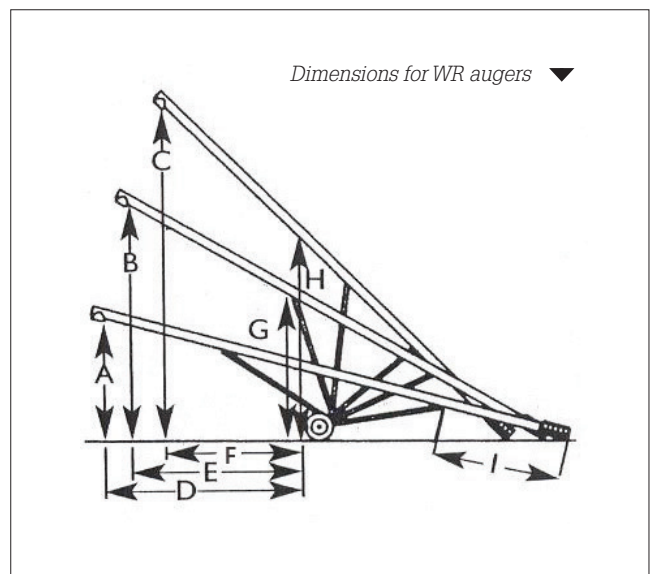

LENGTH	A	B	C	D	E	F	G	H	I
26' / 8,0 m	1950	3840	5450	3270	2870	2200	2350	3440	2080
31' / 9,5 m	2330	4590	6530	4170	3640	2810	2680	3890	2330
36' / 11,0 m	2740	5270	7550	4930	4320	3390	3040	4350	2700
41' / 12,5 m	2910	6130	8680	5670	4960	3840	3490	4960	3090
51' / 15,5 m	3610	7600	10640	7020	6130	4810	4300	6040	3890
61' / 18,5 m	3540	8610	12460	8310	7400	5770	5220	7370	4910
71' / 21,5 m	3890	10030	14290	9620	8540	6840	5970	8360	5600

The auger is delivered unassembled in a galvanized transportation frame.

▶ **WR auger**

▶ **WR inlet hopper options**



▶ **WR electrical motor or PTO-operated**



▶ **Outlet and support wheel**

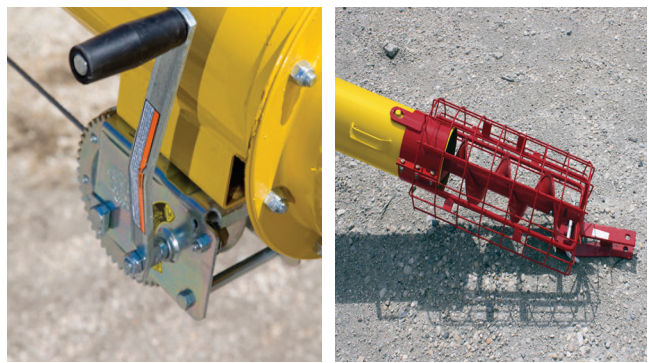

TYPE	DIAMETER	LENGTH	MOTOR	
WR 80x26	8" (203 mm)	8,0 m	5,5 kW	
WR 80x36	8" (203 mm)	11,0 m	7,5 kW	
WR 80x41	8" (203 mm)	12,5 m	7,5 kW	
WR 80x51	8" (203 mm)	15,5 m	11,0 kW	
WR 80x61	8" (203 mm)	18,5 m	11,0 kW	
WR 80x71	8" (203 mm)	21,5 m	15,0 kW	
WR 100x31	10" (254 mm)	9,5 m	11,0 kW	
WR 100x41	10" (254 mm)	12,5 m	15,0 kW	
WR 100x51	10" (254 mm)	15,5 m	18,5 kW	
WR 100x61	10" (254 mm)	18,5 m	18,5 kW	
WR 100x71	10" (254 mm)	21,5 m	22,0 kW	
WR 130x31	13" (330 mm)	9,5 m	18,5 kW	*
WR 130x36	13" (330 mm)	11,0 m	22,0 kW	*
WR 130x41	13" (330 mm)	12,5 m	22,0 kW	*

Accessories for WR augers

- Support wheel kit for 8", 10" & 13" WR
- Cone shaped special outlet Ø160-Ø300 for 6", 8", 10" & 13" outlet
- Big poly hopper. Height x diameter 50 cm x 125 cm
- Hopper 35 gr. for 8", 10" & 13" WR 92X92 cm
- PTO kit for WR 80x51 and smaller
- PTO kit for WR 80x61 and larger
- Flexible outlet spout in poly material: 8", 10" & 13"

Delivered with electrical motor and operation box.
 *) Not standard stock item - longer delivery time must be expected.



Cost-efficient auger with large capacity

A UT auger consists of one basic section (A) with outlet spout and drive unit, extensions (B) available in 3 different lengths and lower section with inlet basket or inlet hopper (C).

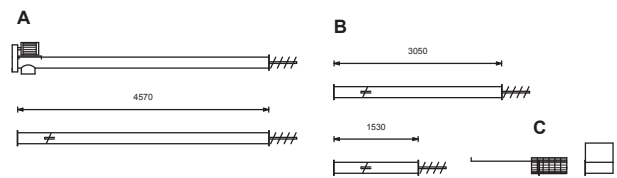

The auger is delivered unassembled.

TYPE	MAX. CAPACITY			
	0°	15°	35°	45°
6" - 152 mm	34	29	22	18
8" - 203 mm	60	51	39	33
10" - 254 mm	102	87	66	56
13" - 330 mm	162	138	105	89

Capacity may vary due to the protection net.

The UT augers are delivered with motor mount, pulley, capacity regulation, bearing for auger fighting, protection screen and mounting fittings.

6" (152 MM) AUGER	MOTOR SIZE
Auger type UT 6" x 5,0 m	1,5 kW
Auger type UT 6" x 6,5 m	2,2 kW
Auger type UT 6" x 8,0 m	3,0 kW
Auger type UT 6" x 9,5 m	4,0 kW
Auger type UT 6" x 11,0 m	4,0 kW
Auger type UT 6" x 12,5 m	5,5 kW
Auger type UT 6" x 14,0 m	5,5 kW
Auger type UT 6" x 15,5 m	7,5 kW
10" (254 MM) AUGER	MOTOR SIZE
Auger type UT 10" x 5,0 m	3,0 kW
Auger type UT 10" x 6,5 m	4,0 kW
Auger type UT 10" x 8,0 m	5,5 kW
Auger type UT 10" x 9,5 m	7,5 kW
Auger type UT 10" x 11,0 m	7,5 kW

8" (203 MM) AUGER	MOTOR SIZE
Auger type UT 8" x 5,0 m	3,0 kW
Auger type UT 8" x 6,5 m	3,0 kW
Auger type UT 8" x 8,0 m	4,0 kW
Auger type UT 8" x 9,5 m	5,5 kW
Auger type UT 8" x 11,0 m	5,5 kW
Auger type UT 8" x 12,5 m	7,5 kW
Auger type UT 8" x 14,0 m	7,5 kW
Auger type UT 8" x 15,5 m	11,0 kW
Auger type UT 8" x 17,0 m	15,0 kW
Auger type UT 8" x 18,5 m	15,0 kW
13" (330 MM) AUGER	MOTOR SIZE
Auger type UT 13" x 6,5 m	15,0 kW
Auger type UT 13" x 8,0 m	18,5 kW
Auger type UT 13" x 9,5 m	18,5 kW
Auger type UT 13" x 11,0 m	22,0 kW
Auger type UT 13" x 12,5 m	22,0 kW

*) Not standard stock item - longer delivery time must be expected.



Accessories for UT augers

Flexible outlet spout in poly material: 6"	Length 90 cm 5-part
Flexible outlet spout in poly material : 8-10"	Length 90 cm 5-part
Flexible outlet spout in poly material: 13"	Length 125 cm 5-part
Wire strengtheners for 6", 8" & 10" UT augers	
Extra mounting fittings for 6", 8", 10" & 13" UT	
Big poly hopper	Height x diameter 50 cm x 125 cm
Big poly hopper for 13" auger	
Handy steel hopper with flight supp. bearing for 6", 8" & 10" auger	
Lid for 6" & 8" inlet hopper Ø200	
Lid for 10" inlet hopper Ø250	
Cone shaped special outlet Ø160-Ø300 for 6", 8", 10" & 13" outlet	
Inlet hopper for auger screw foot with supp. bearing for 6", 8" & 10" auger	

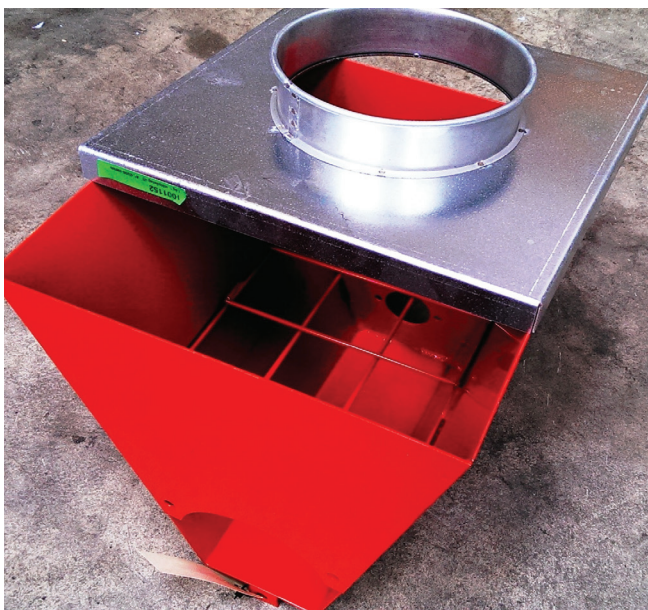
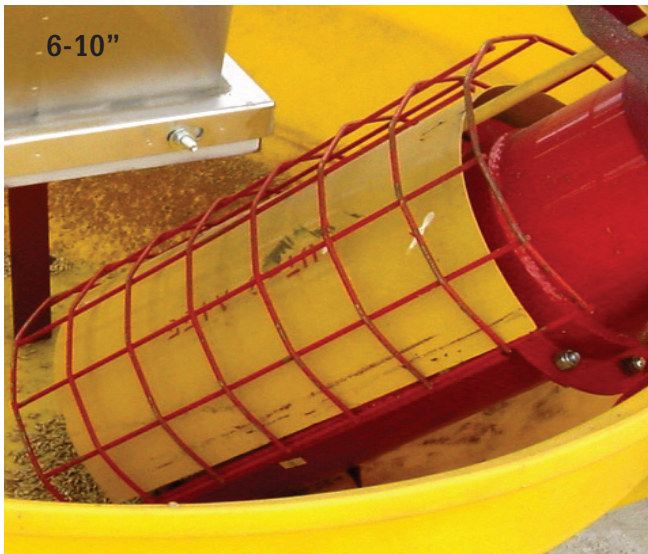



Type B-16 to be mounted on the rear of your wagon

With the Westfield auger for grain and fertilizers on your wagon, you can easily and quickly handle large quantities of grain and fertilizers. The auger is mounted quickly with only one assembly bolt and without use of any tools.

Fold easy and quick to transport position incl. hydraulic motor, electric operated start/stop function mounted at the end of the outlet tube.

The auger is delivered incl. remote control.

Capacity:

25 - 30 t/h

Dimensions:

The length in working position is 4.7 m.

The pipe diameter is 6" (152 mm)

